

# Шкаф купе 2дверный СБ-2675 ДАКОТА

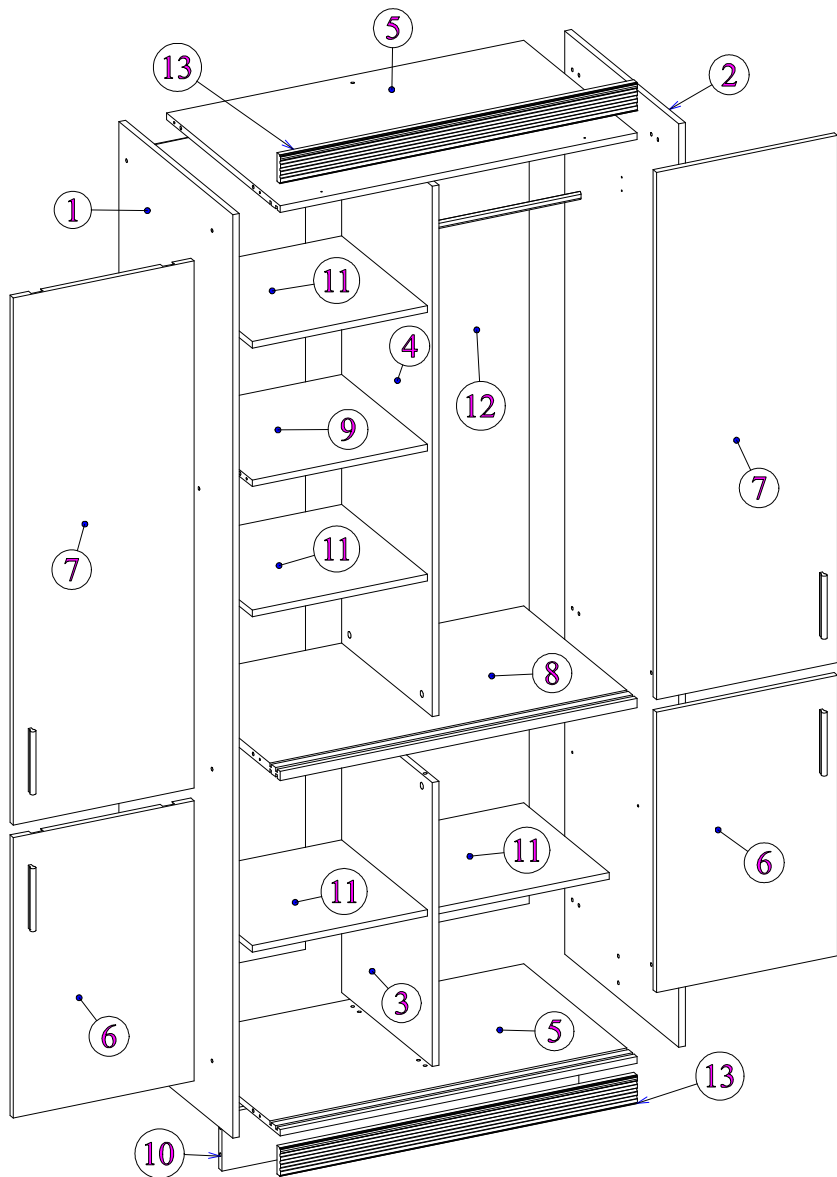

1	2200	554	16	1	1/3
2	2200	554	16	1	1/3
3	676	440	16	1	2/3
4	1264	440	16	1	2/3
5	868	552	16	2	3/3
6	668	440	16	2	2/3
7	1256	440	16	2	2/3
8	868	552	22	1	3/3
9	426	416	16	1	2/3
10	868	136	16	1	3/3
11	426	416	16	4	2/3
12	1990	448	3	2	1/3
13	868	68.4	17.4	2	3/3

301	1.6x25	208	Φ3.5x18	205	4x16	209R	4x25	602	4x13	406	Φ7x50	461		410	Φ8x30	735	737	738
x48		x8		x4		x10		x32		x20		x20		x24		x8	x8	x8
739	L=866	417	2xL=84	561	L=64	405		KL-128		449		412	L=420			470	411	001
x8		x2		x2		x16		x4		x2		x1		x4		x4	x2	x1

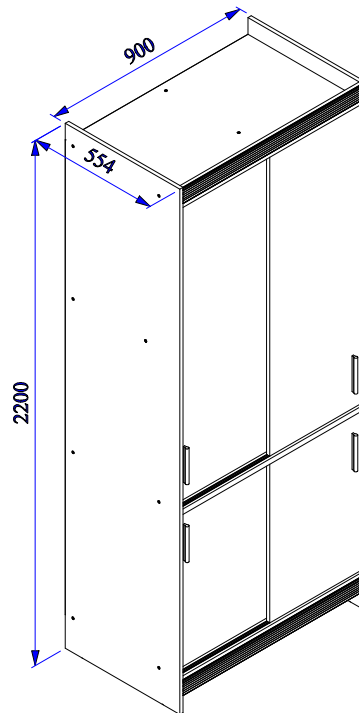
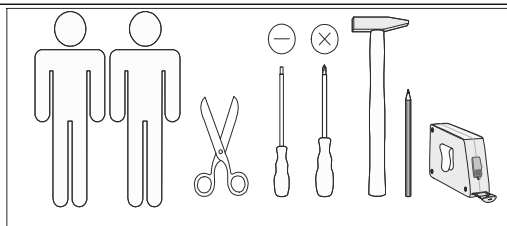
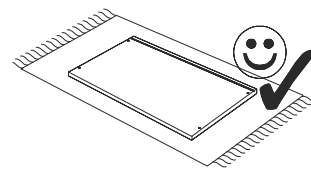
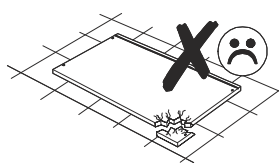
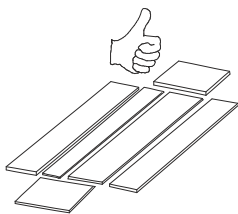
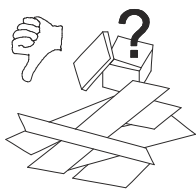

# Шкаф купе 2дверный СБ-2675 ДАКОТА

1

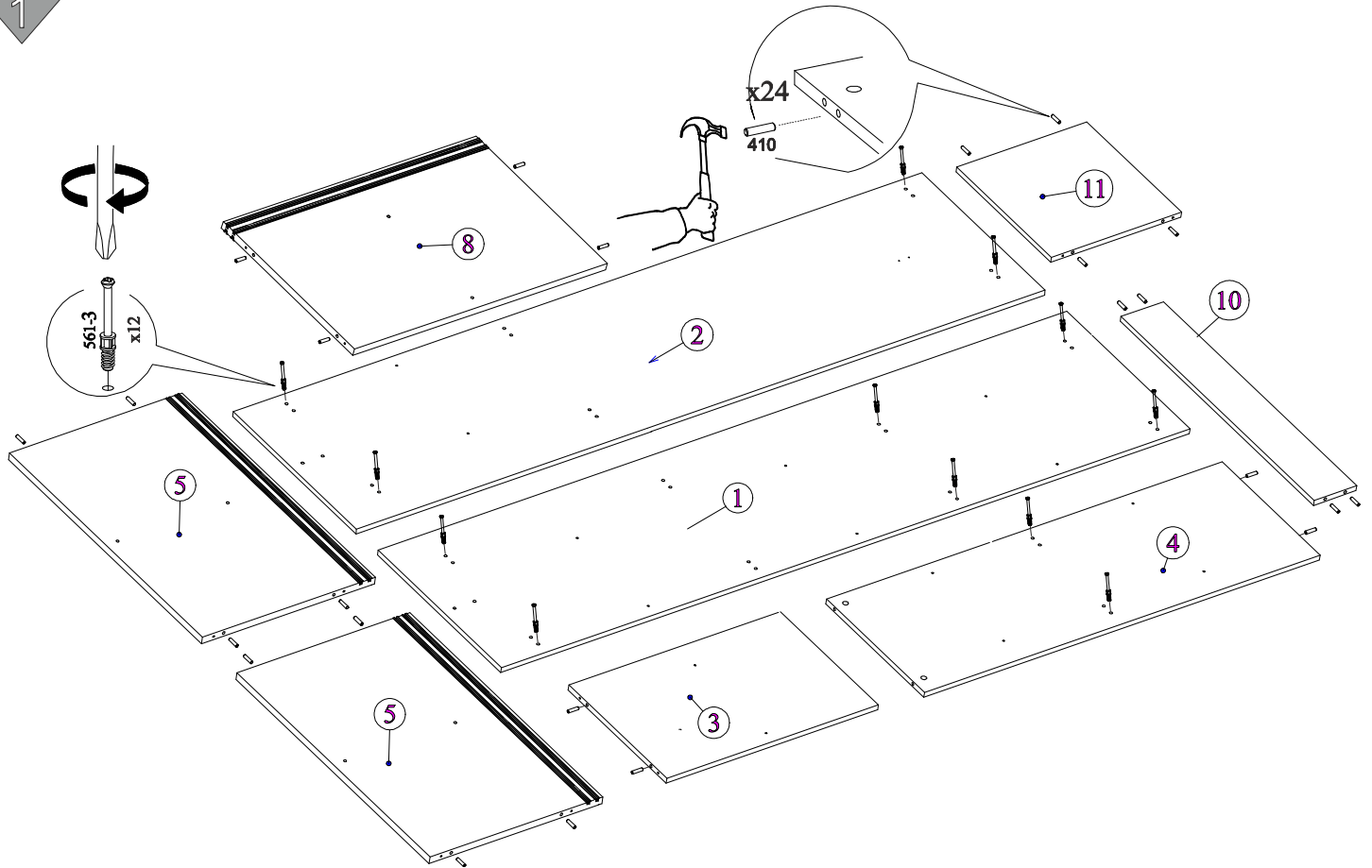

2

1. Ролик поз.737, после регулировки фиксировать по месту саморезами 4x13 поз. 602
2. Подкладка поз.449 крепить на переднюю дверку шурупами поз.209R

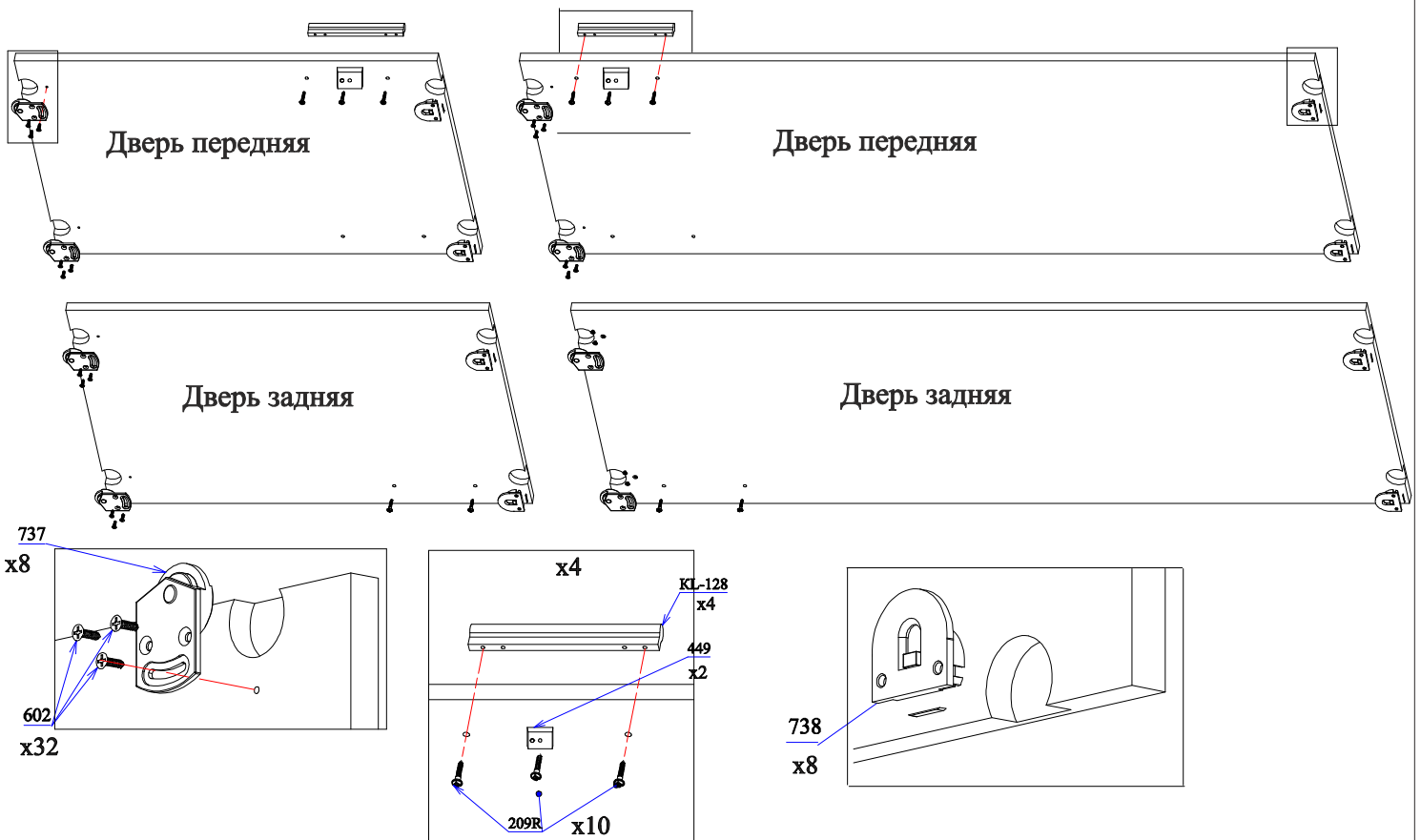

# Шкаф купе 2дверный СБ-2675 ДАКОТА

3

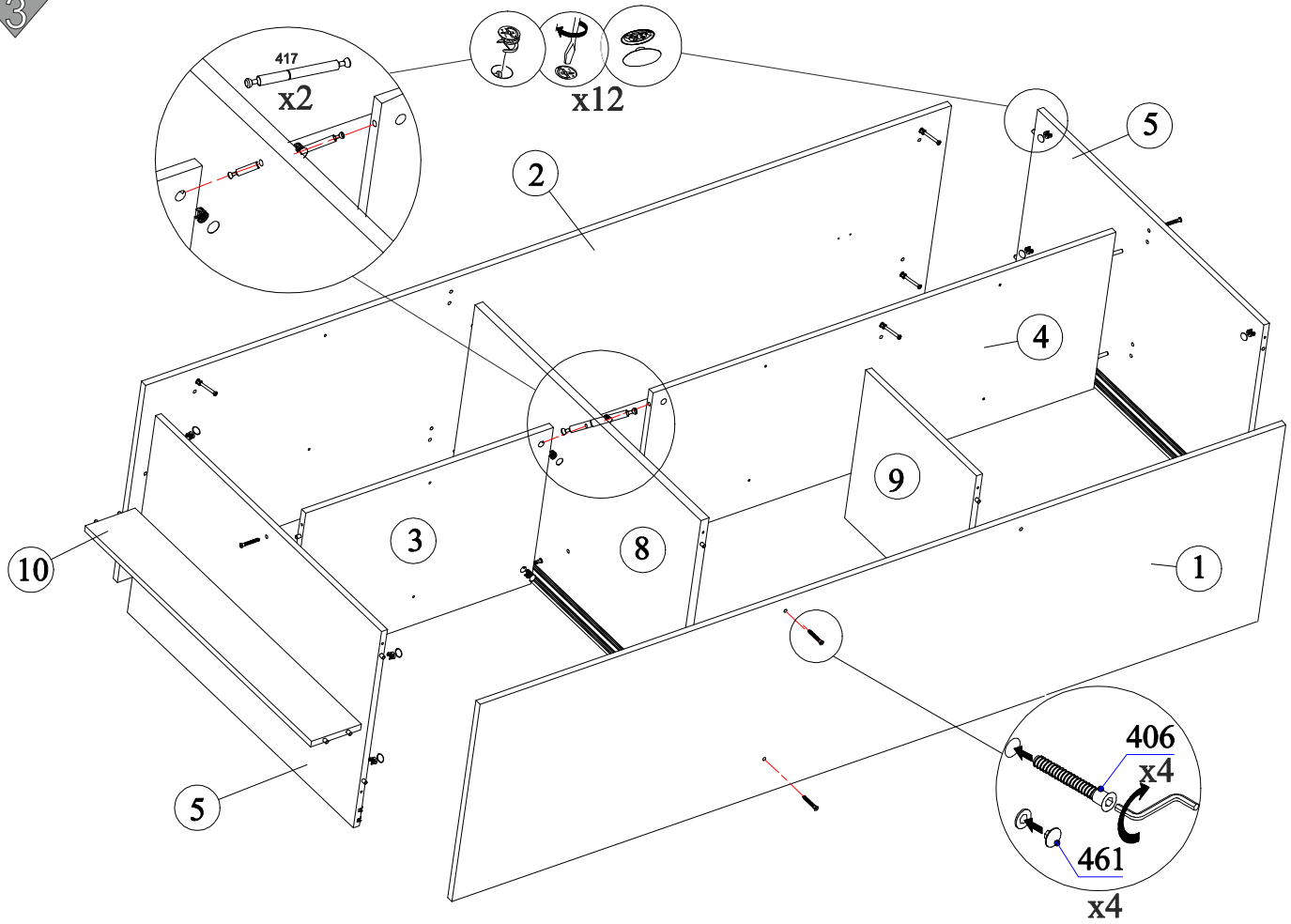

4

